

**1961-63
FORD**

Thunderbird

**Disc Brake Install
Guide**
for

ACC & Similar Disc Brake Kits



ACC Disc Brake Kit Installation Tips



A Note From the Authors...

If you're reading this, you're clearly a smart individual, and we know this for a few reasons. First - there's a pretty good chance you've acquired

a 61-63 Thunderbird and second, you're likely considering adding disc brakes – both smart decisions in our book. You've also decided to take the time to do a bit of research and have picked up this guide. As a smart individual though, you understand that there's more than one way to "skin a cat" and that the same applies to disc brakes on a classic T-Bird. What you have here in your hands (or staring at you from your screen) is the summation of 2 guys experience, tips, tricks and insights on a particular kit. This is not the "Omnibus Compendium of all Thunderbird Disc Brake kits, volumes I - IV" In addition, there are methods of updating your bullet-bird to disc brakes without using a "kit" but rather repurposing later year T-Bird components. We intend this guide as a good resource, regardless of what kit you use (if any) and a reasonable (not to mention necessary) addendum to the instructions provided with the AutoCity Classic (ACC) kit.

This guide was created from the forum post at Vintage Thunderbird Club International (VTCI), so it will read more like a forum post than a written guide, but it contains the thoughts, insights, musings (and frustrations) of Allan and Dave - VTCI forum members, T-Bird owners and while largely unintended, ACC kit experts. We've provided our thoughts below and since we attacked this project independently, we've provided notes and call-outs where things were different in our kits, or where we want to call your attention to something that differed in our approach or solution. Remember that this is a guide, not a step-by-step manual, and that when it comes to modifications to classic cars, no two projects are exactly alike.

Good luck!

Regards,

Allan: VTCI username: Treozen. 1963 Thunderbird HT

Dave: VTCI username: bigbrownpilot. 1962 Thunderbird HT

Topic	Page
Introduction	4
Parts List	5
ACC kit Instructions	6
Spindles	7
Brackets	10
Calipers	12
Vacuum Booster	17
Mounting the Master Cylinder	22
Proportioning Valve	24
Brake lines & Flares	30
Residual Pressure Valve	40
Bleeding Brakes	42
Additional Topics	42
- Pre-Bent Lines or Stainless Brake Line?	42
- Stock 14" Wheels – Do They Fit?	43
- Low Drag Calipers?	43
- Brake Hose & Banjo Bolt Leaks	44
- Booster Fitment	45
- Is This a Bolt-On Kit?	46
- Final Thoughts	47
Appendix	48
- Vacuum Booster to Pedal Assembly Diagram	48
- Vacuum Booster – Exploded View	49
- Push Rod Linkage	49

The ACC "Complete" Kit:



Point of note here folks – This is the ACC "Complete Kit" and does not come with the brake line or brake line bending / cutting tools pictured. Also, after working with the Kit, both Dave and I came to the conclusion that you're better off buying the basic kit anyway.

- Allan

I thought I'd start you out with some basic data:

Kit type: Front only, complete kit, included Booster and Master Cylinder

Manufacturer: Auto City Classic

Cost: \$650 shipped

Purchase path: Direct from Auto City Classic but they sell on eBay also

Grades:

Material / parts quality: A- (bearings looked to be cheap imports, otherwise, good)

Bracket Hardware: A

Instructions: F (half a page...seriously)

Bolt-on Kit status: D













Customer service: Poor (F)

Overall Grade: About a C if you have some experience, D- if not.

I've provided a "complete Kit" parts list with comments on the next page, though as you'll read, we ended up changing out the booster.

So, I'm a tough grader – but really, you shouldn't expect any "bolt on kit" to be truly bolt on – Personally, I've never met one that has been.

- Allan

Part	Picture	Quantity	Original Application	Part number(s)	Notes
Spindle Adapter		1	None - made for the kit. however, it seems that most kits use the same or a very similar adapter.	N/A	Basically just a metal sleeve that slides over the spindle
Caliper Brackets		2	None - made for the kit. I've seen at least two kits use this bracket system	N/A	Lots of different brackets out there - these seem very robust and well-built out of thick material.
Rotor		2	1975 -80 Ford Granada, Front	5419 (Autozone) NB 4885564 (NAPA) 6042RGS (O'Reilly)	None of the rotors at the autoparts stores will be drilled / slotted. The rotors came that way in the kit.
Calipers		2	1982 - 1995+ Chevy S-10	C160 (Autozone, L) C161 (Autozone, R) CAL N4623 (NAPA, L) CAL N4622 (NAPA, R)	Almost all of these calipers have a casting bump that interferes with the bracket. You will need to cut it off.
Brake Lines		2	Not Sure	Not Sure	Not sure what these are from, but you need a banjo-bolt style end for the caliper and a female port on the other end for a 3/8ths fitting. Looks to me like most early disc cars have that set-up, design varies a little but I'd guess most would work. 78 Monte Carlo or 78 Malibu - check length.
Combination Valve		1	Varies, GM application	MBM PV2 (Amazon.com)	This style of combo valve was used for years, most GM Disc / Drum cars will have used something very similar - I got my first one from a junk yard - worked fine.
Inner bearing		2	Not sure - likely Granada, but hard to say	A13 (I think)	The A13 is the stock inner bearing for the Granada rotor, but I cant say for sure that's what came in the kit.
Outer bearing		2	Multiple	A34 for 1963 Possibly A2 for '61 & '62	The spindle for 63 is different than that of 61 and 62 - not sure how but based on the bearings, it must be a bit thicker because the A34 bearing has a larger bore than the bearing that came in the kit for 61 & 62.
Wheel Seal		2	Multiple (stock for Granada rotor)	D6815 (Autozone) NOS 19221 (NAPA)	Making an assumption here, but seems reasonable that the wheel seals would be stock for the rotor.
Master Cylinder		1	GM for sure, and I'm 99.9999% sure its C3 Corvette	Assuming C3 Corvette: NM1749 (Autozone) NMC P2300 (NAPA)	There is a version of this M/C with bleeder valves above each port - might be worth looking at.
Booster		1	7-inch "hot-rod" style power booster	Varies	I'm not necessarily suggesting you use the one that came with the kit, I recommend using a 9" booster. But the 7" booster is available from multiple sources (Summit, Jegs, look in hot rod magazines, etc)
Brake Lines (metal)		Depends	None - 1963 T-Bird runs 3/16ths throughout. You can use what you want, I went with 3/16ths - it matches the M/C ports and the rubber hoses.	Varies	Sort-of optional - you could possibly reuse the front lines and the rear can be re-used for sure - but you need to be very careful bending those lines. Buying it in a roll is probably best. Options include standard steel, stainless and Copper-Nickel Alloy (which is what I used).

Instructions That Come With the Kit

Here are the instructions that come with the kit, such as they are...

ACC liked Dave better than me, and gave him better instructions (below). Yes, these are the BETTER instructions, so guess what mine looked like.

- Allan

61 - 64 FORD THUNDERBIRD FRONT DISC BRAKE KIT INSTALLATION

Support the front of the vehicle on jack stands. Remove front brake drums, backing plates and flexible brake lines from both sides. Clean the spindles, including the spotfaces in the back. Install the front spindle bracket using the 3/8 x 1 1/2" and 1/2 x 3" bolts with the lockwashers and nuts on the back side, do not tighten. Attach the caliper bracket to the spindle bracket with the 3/8 x 2 bolts and lockwashers. In some cases the lower spacer bushing on the caliper brackets might interfere with the spindle, if so grind clearance on the spindle. Apply Loctite to the 3/8" grade 8 bolts and tighten to 45 - 50 FT. LBS., make sure to install the lock washers. Apply Loctite to the 1/2" bolts and tighten to 75-80 FT. LBS. *[FYI that neither Dave or I had to grind anything]*

Now you will have to heat the bearing spacers with a torch to a dull red. DO NOT OVERHEAT! Slide the heated spacer over the spindle with a pair of pliers and push the spacer with a piece of pipe large enough to fit over the bearing journal until firmly seated. You might have to tap the pipe with a hammer. Make sure the pipe seats against the larger flat face. Do not try to install the spacer without heating. After it cools slide the inner bearing over the spacer, it should slide on easily. If not, polish the bearing journal with emery cloth until it slides on and off easily. *[I'm not sure if this is specific to the '62 or not, but my instructions didn't contain this passage at all, and I didn't have to heat anything to make it work, I did do some light work on the adapters, see below]*

Make sure the bleeder is at the top when installing the calipers. Finish assembling the remaining parts. DO NOT Loctite the caliper slide bolts. Install the new flexible brake line and turn the wheels all the way right and left and check for interference, adjust accordingly and tighten. You must bleed the brakes before attempting to drive the vehicle. Most 15" wheels and some later model or aftermarket 14" wheels will fit.

Let's Talk Spindles

The kit I used and at least one other kit for sure, use a "spindle adapter" so that the inner wheel bearing will fit. I'm not sure if all kits use an adapter but all of those I looked at (that have a picture of the kit) seem to - in some cases, it looks like the exact same one.

Here is what it looks like:

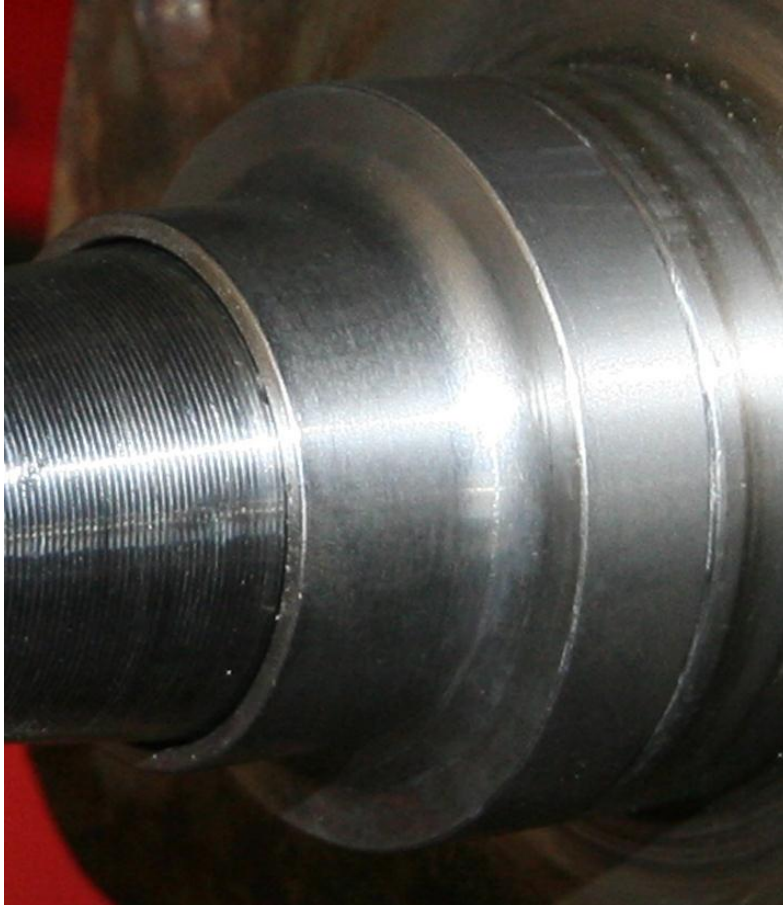

There are a few VERY important things you need to know / do in terms of the spindle adapter, so here they are:

1) The spindle adapter will slide inside the inner bearing but the tolerances are extremely tight. A tight fit in this case is a good thing, but you also need to be able to get the bearing on straight once you have it grease-packed and installed in the rotor. You **MUST** test fit or you risk getting your bearing stuck on crooked.

I test fit mine and found that one set of bearings and adapter fit pretty good, but the other was so tight I could not slide the bearing on, in fact, it got stuck almost immediately and I had to use needle-nose pliers to pop it loose. There was no way this bearing would slide over the adapter straight. The solution was to use some 320 sandpaper and two grades of wire wool. I worked on the outer surface of the adapter for the most part, but gave the inner bearing surface a clean with the wire wool as well. The trick here is that you want it to be tight, but not so bad that you can't get it on at all. I went slowly, took about an hour (I did both adapters). When I got done, I could slide the bearing on very carefully and it wouldn't get hung up, but I had to be careful and a slight rotation helped. To be clear - this

shouldn't "slip" on and off, even after I got done, the bearing and adapter would bind up if you didn't have them aligned properly. The advantage was that getting them apart again was easier. Make sure you have a nice fit because you don't want to wait until you have your wheel seal on and everything covered in grease to discover the bearing won't go on or seat properly.

2) Again with tolerances - the fit from the spindle itself to the inner surface of the adapter is also very tight. I was able to slide one side on to about 1/4 inch from the mounting surface, so that was ok, the other side however was still a good inch at least away. Again, I used sandpaper - but a little more aggressive grit - 220 and I may have even started with 180. I worked on the spindle itself - you only want to clean it up really, not remove a bunch of material - so check your fit often to be sure you don't go to far. Once I could get it on within a 1/4 inch, I called it good.

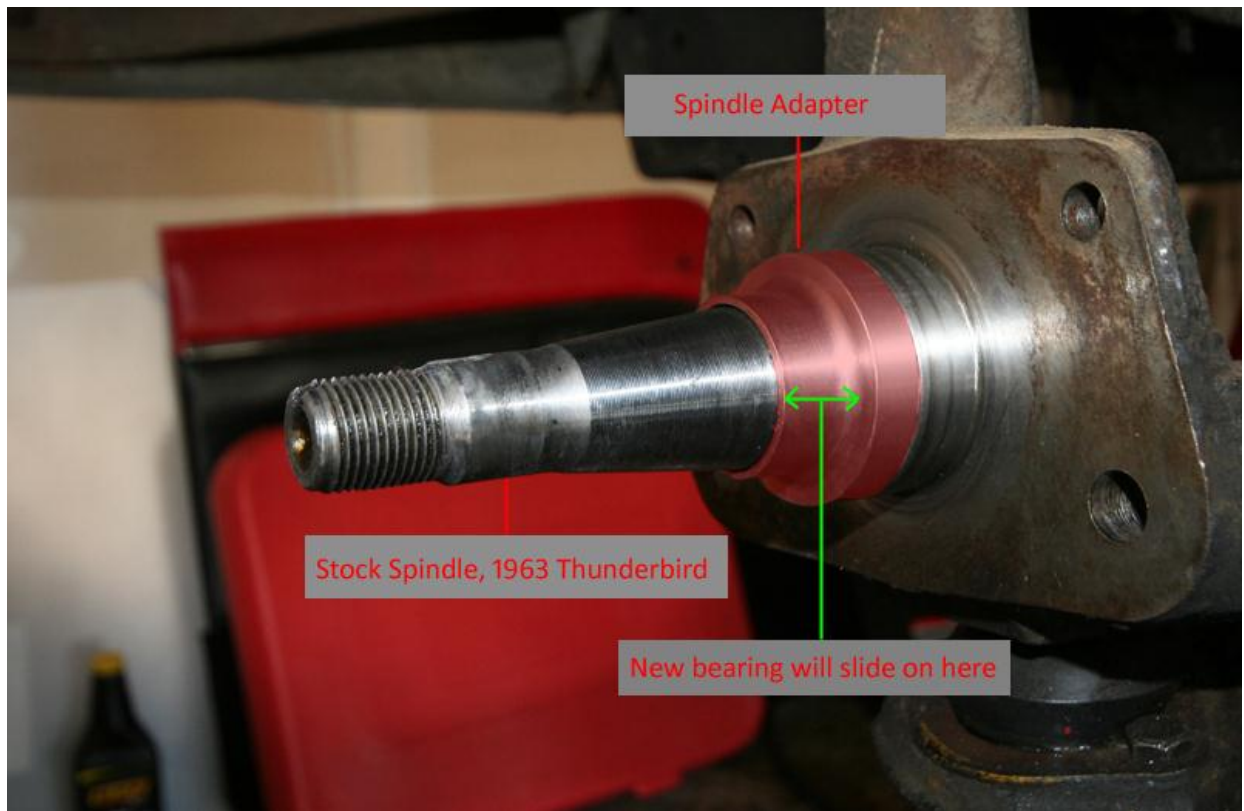

3) How do you seat the adapter that extra 1/4-inch? With a mallet of course! I used a piece of 8 X 1 1/2 inch pipe (bought from Lowes) slid it over the spindle and used a RUBBER mallet to TAP the adapter on the rest of the way. If done correctly, you shouldn't need to use a sledge or anything - you risk damaging the adapter or putting it on crooked - and good luck getting it back off if you've smashed it on. I hit it firmly, but not at a full swing or anything. Both adapters seated nicely without any fuss.

Here is a picture of the install



Brackets

Now - the brackets. There seem to be many different types of bracket used, these ones look to be well made and out of the proper gauge material. Despite the dismal instructions, they installed easily enough.



The bolts are Grade 8 fine-thread. The 1/2" bolt and 3/8" bolt that fit through outer bracket and the spindle are secured behind the spindle with self-locking nuts and a little red Loctite. The remaining three 3/8" Grade 8 bolts will not protrude from the back of the inner bracket. There are internal fine threads in the inner bracket and the bolts thread into the bracket itself. Again, a little red Loctite should be applied to the threads.

- Dave



I'm not as brave as Dave, I used Loctite Blue 242

- Allan

Finally, a shot of the rotors installed. I probably don't need to cover packing bearings and installing the wheel seal, but obviously I did that.



Another thing to note here is the Cotter pin. I had some trouble getting my driver's side pin to fit, almost as though the spindle nut wasn't on far enough and the gap left wasn't wide enough to let the pin pass through. This is an issue that impacts other kits as well, so you may encounter it. The key thing here is that you want to avoid the temptation to jamb on your spindle nut so that the Cotter pin will fit easily. You do want the spindle nut to be appropriately set, and you obviously do want the Cotter pin installed, but cranking down on the spindle nut will just wear out your bearings.

First thing I did was go to Lowe's and get a thinner Cotter pin. The one that comes with the kit was pretty big – bigger than it needed to be. It probably still took me about 30 minutes to get the driver's side pin installed (it should take 5 seconds) and I had to be creative with pre-bending it and sort of "hooking" it through the hole. I also used some vice grips to grab the end of the pin and help yank it through. This was very frustrating, but in the end, I got it in and I didn't have to crush my bearings to do it.



Calipers.....

I'm 99.99999% sure the calipers are Chevy S10. They look like S10 and more to the point, I test fit a set of s10 calipers I bought myself and they fit like a glove. All the kits I've seen appear to use the exact same caliper - unless you go more expensive and want a dual or quad piston set-up.

This is a good thing because GM used this caliper on the S10, its GMC variant the S15 and various other GM truck / SUVs from 1982 through at least 1995 which means they are available at the local parts places ...and for about \$15 each (plus core).

Unfortunately, as the "Fine Young Cannibals" once said - "good thing, where have you gone"?

The calipers I got with the kit didn't fit. Yes that's right - didn't fit and the reason they didn't fit was clear as day. A simple test fit by Auto City Classic would have identified the issue, because honestly, Stevie Wonder on his worst day could have seen the problem... let me illustrate:

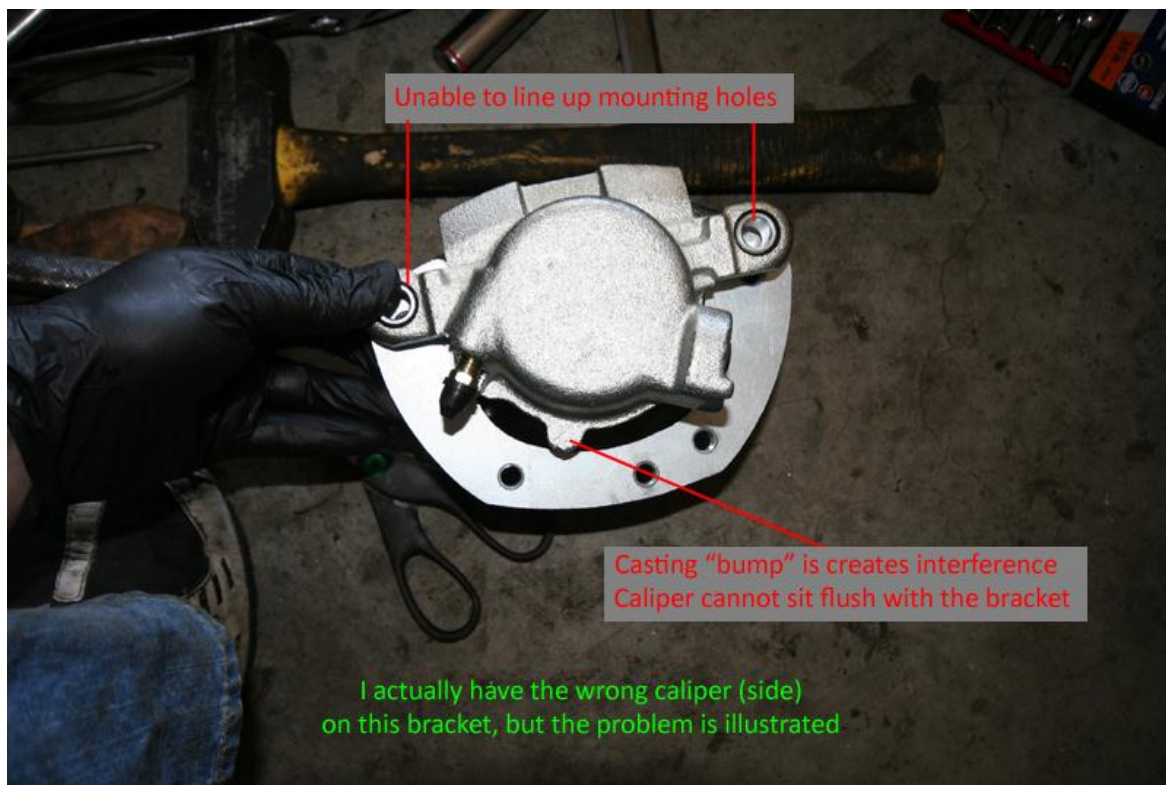

Now, you might be thinking - "so grind it off" and in essence you're right, but this is supposed to be a bolt on kit, designed for this car, and to work with the brackets provided. The fact that Auto City Classic couldn't make sure the calipers they sent fit their own bracket, was more than a little disconcerting. I also noticed that in the picture they used to advertise the kit, the caliper does not have this casting bump. This was to be somewhat of an omen of things to come.

I reacted (as I usually do) by being very irritated and not thinking clearly. So rather than just cut off the bump, I decided to abandon the calipers entirely and get something else. I did a bit of research and found that it seems these calipers did not always have this bump - perhaps OEM don't but anything available as a re-manufactured or new does? In either case, I also discovered that the 4X4 version of the caliper (same truck, same year) didn't have the bump - so I bought those. BUT another issue.... the 4X4 calipers have the rubber brake hose coming out of the top, rather than the bottom. This means the hose is in real danger of catching on the sway-bar link and even if you "fixed" that, the angles the hose would need to achieve while turning seemed a little extreme. So with a clear head the following day...



I tried a straight grind - it would have taken forever. I've really no idea why I didn't think about the hacksaw earlier; well...except that I was blind with fury 🤡 but the next day I just naturally thought "why not cut it off you idiot" and the hack saw worked wonderfully - almost as though its made to cut metal..... 🤡 It took mere minutes and I got this:

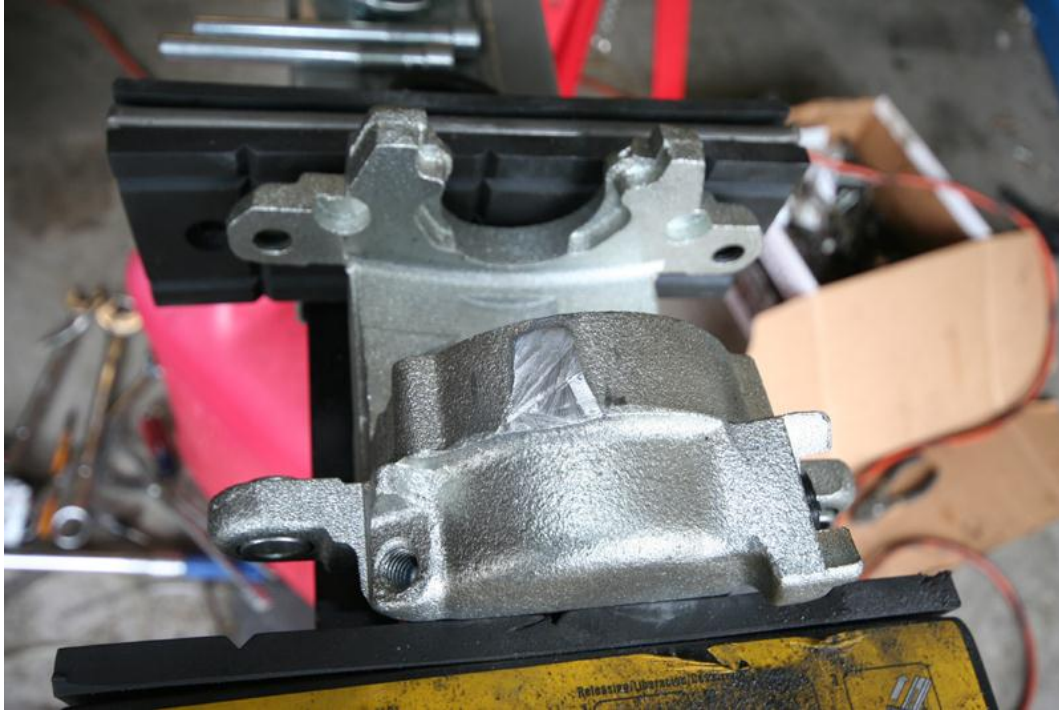

and then with some help from my angle grinder...

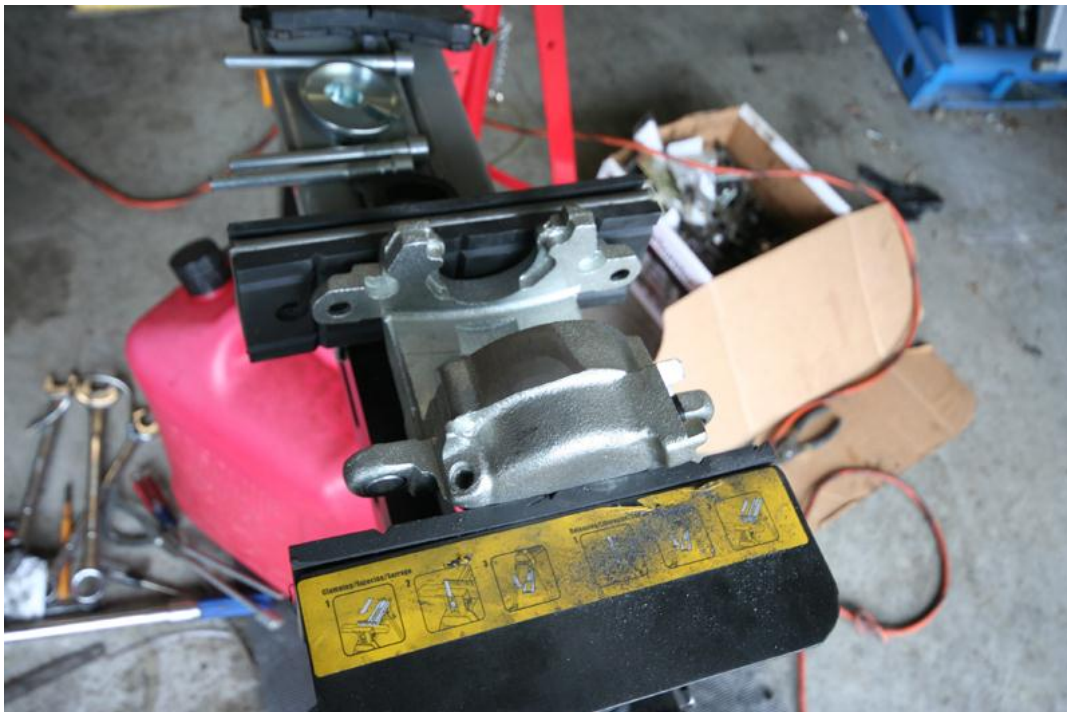



This resolved the issue and the caliper fit perfectly. It took no more than 10 minutes to "fix it" so that everything lined up. So when all is said and done - not a big deal in reality, but in principle... come-on Auto City Classic... REALLY?

Pad spacers: The kit should come with them. In this kit, they are round and slide into the caliper piston. Other spacers are either round (like these) or look like the back of a caliper pad with the friction material removed - but same function. Make sure you use the pad spacers because they help account for the differences in rotor thickness (The stock rotors these calipers are designed for are thicker than the Granada rotors used in the kit).

So...that's Calipers. Last point of note here - the calipers I received with the kit did not have any part markings. I believe they are part number P4071 (AutoZone) as that part number is a loaded pair of calipers and the only ones I can find in the silver paint. Pretty much any Chevy S-10 caliper will work however. The limited instructions do provide one important point, make sure you install the calipers on the proper side - with these ones lacking an "L" or "R" or a part number, the way to know the proper side is to make sure you install the caliper so that the bleeder valve is at the top (and in this case your rubber brake hose will attach to the bottom). If you accidentally put them on the wrong side, chances are everything will fit, but you'll never get the air out and you'll be bleeding the brakes forever (ask me how I know that). If you buy the calipers yourself (part numbers provided at the top of the thread) or get a different kit, chances are you'll get a caliper with a "L" or "R" designation.

P.S: Left / Right is determined by the drivers position as though driving the car - so Passenger side is RIGHT, Drivers side is LEFT.

The Final Assembly....



Time to Tackle the Booster.

***Update to original post ***

The update is that the 7-inch booster provided with the "Complete Kit" is too small in my opinion, and that opinion is generally shared "out there" on the inter-webs for a vehicle as heavy as the 63 T-Bird. There are other things you could do but the easiest might be to install a 9" booster – and that's what I've done (as did Dave). A 9" booster will be about the same as a dual-diaphragm 7" in terms of power assist, but the dual diaphragm boosters are physically longer and when using the master cylinder as in this kit, along with the original booster bracket, you just won't have room. The 9" fits perfectly though and the only modification was that I had to shorten the threaded rod in the back of the 9" booster so that the length of the threaded rod was the same as that of the 7" – so hacksaw, cut-off wheel, etc.; – nothing crazy. The 9" booster I used was an aftermarket booster – same or similar brand as the 7" – very common to find them in hotrod magazines or the web- eBay as well if you're into eBay. I bought mine from eBay as "slightly used". Since I wasn't sure it would fit I didn't want to buy a new one, – but it does fit and as an added bonus, also works just fine. I need to adjust the booster to M/C pushrod to account for some pedal travel, but regardless of any adjustments I still need to make, you'll be happier with the 9" booster and I'd recommend it over the 7". Note that the modifications and installation as below all apply to a 9", only thing that changes is the size of the booster 😊

The first thing I need to do is ask for forgiveness - by the time I figured out what needed to be done - (which ended up being simple, but I was tired and hungry and annoyed, so it took longer) I had forgotten to take pictures 😞

So instead, I searched the vast inter-web for appropriate pictures that would let me illustrate the steps, and then stole them 😬 Next page please.....

OK - this is actually the exact booster that comes with the kit - picture comes from the kit itself, I just didn't take it.

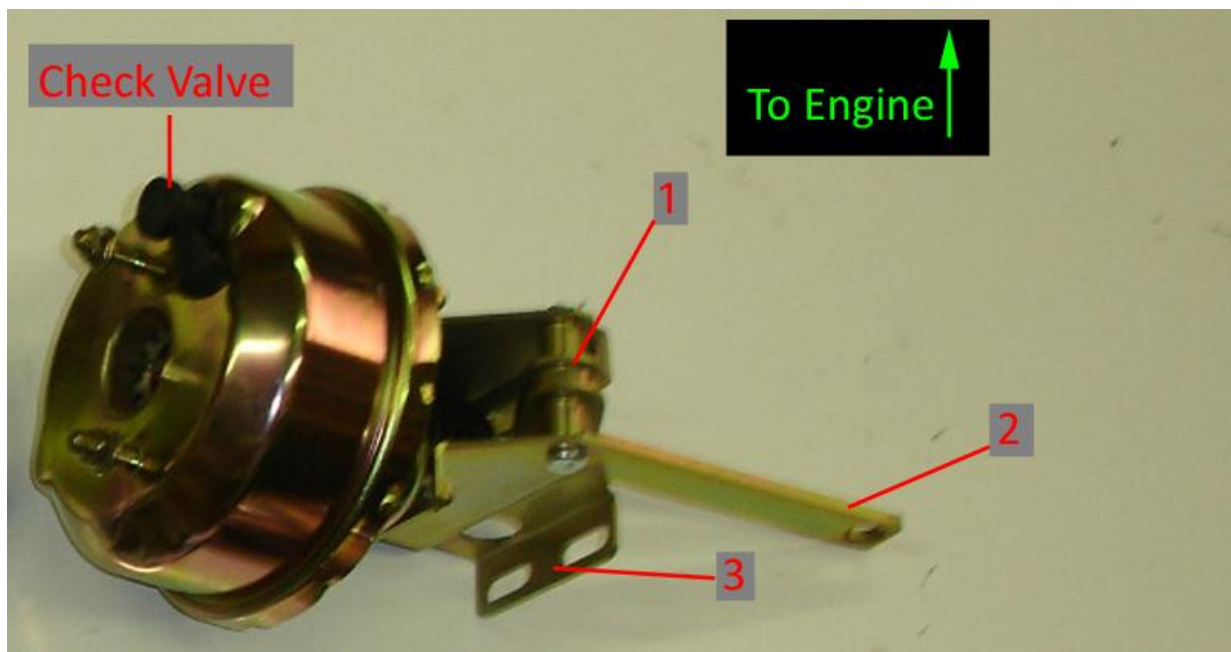

So what's wrong with it... well....

- 1) Either the bracket is on upside down, or, the bracket is designed for a different make of car. In the picture, the "pivot point - (item 1) is at the top, it should be at the bottom. I've rarely seen a booster mounted as shown in the picture - for one thing, the angle of the bracket tends to push the booster further down into the engine bay rather than lift it up, which is also more typical. Either way, point is, the only way to mount the booster in this configuration was to turn it upside down.... not that it mattered... see item 2:
- 2) Regardless of how (or if) you mounted the booster, the rod was several inches too short. A quick comparison to the stock rod made that clear.... but again, rather a moot point, see item 3:
- 3) The bolt holes did not line up to the firewall holes - period. I don't care if it was upside down and too short, it wasn't getting bolted in anyway. An added frustration was that the original bracket had pressed-in bolts so that you could A) get the nuts on the other side fairly easily and B) not drop (and consequently, loose) bolts out of the holes every time you nudge the booster.

So long story short - clearly this was an assumption made by Auto City Classic....*"if it fits other fords, it will work for the T-Bird"* 🤖

The solution was actually very simple, but since I wasn't aware of all the "upside-down, too short, won't mount anyway" issues, I had to work my way through them to get to it. So, what's the solution?.....quite simply, mount the new booster to the old bracket!!

First, remove the bracket from the new booster, including all the linkage; you'll be changing that too. You'll end up with this:



Next, let's look at the old bracket and linkage...



1) You want to attach the booster push-rod to this linkage. Item 3 here indicates that you may need to run a spacer or two on each side - I used washers - all they need do is take up some of the space and center the push rod.

2) Here is where you need to do a bit of modification. The old booster's mounting studs are a little further apart top to bottom, so the holes in the bracket will not line up with the new booster's studs. The good news is that its close - you probably only have to elongate the bottom holes a 1/4 inch - the yellow highlight marks the spots. I used a Dremel tool with a grinder bit. Best thing to do is put the bracket on the top booster mounting studs and then see how much you need to enlarge the bottom holes. You can of course do the reverse-- modify the upper holes.

The fit is tight because the center bore of the new booster seems a bit larger than the old one, but it does fit. In an unfortunate bit of strategy on my part, I had previously removed one of the pressed in studs on the old bracket by unceremoniously whacking it with a hammer.

This did two things - removed the bolt and bent the mounting plate a bit. As a result, my bracket didn't quite line up with the firewall holes anymore, and I had to bend it back into

shape - my point in telling you this is that while I don't *think* you'll need to do the same, I can't be sure the width of the new booster mounting studs wasn't slightly narrow versus the old, so you may also need a minor tweak to get your bolts to line up - but very minor.

Ultimately, you'll get something like this:

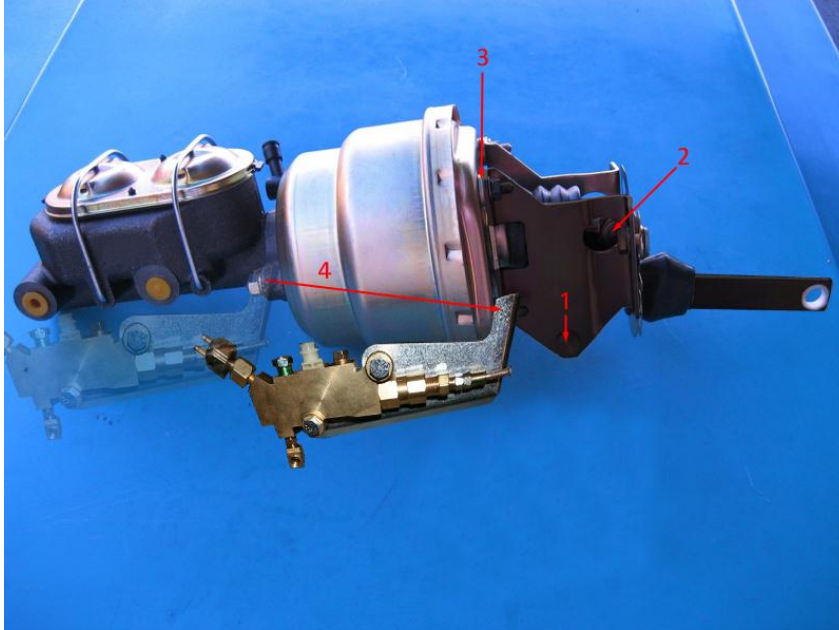

NOTE: This picture does not show the correct mounting bracket (stock '63 at this point in the build) but it is close enough for me to point out the important parts.

- 1) Be sure you have installed the bracket with the pivot point down.
- 2) Make sure you have added the necessary spacers and used either the cotter pin or retaining clip so that the booster push-rod stays put.
- 3) Don't forget the spacers! There are 4 spacers that go between the booster and mounting bracket - they are thicker than those shown here, but same function and location.
- 4) Number four has nothing to do with the booster, but it's a good time to tell you about another modification. The "proper" mounting location for the proportioning valve using the bracket provided in the kit, is on the stud that mounts the master cylinder to the booster (as shown with transparent prop valve). However, there is no room to do this because the shock tower is in the way. The simple solution is to locate the prop valve a few inches further back and then use the bottom booster-to-bracket mounting stud instead. You won't be able to use the provided Prop valve to Master Cylinder metal lines, but you've no choice really and making new lines that fit is easy enough. Also, if per the update above, you are using a 9" booster instead of the provided 7", it's unlikely the bracket will reach the booster stud due to the increased diameter of the 9" booster. In this case, it's simple enough to fabricate a mounting solution or use a piece of flat steel to extend the reach of the bracket.

Lastly - I felt some of the linkage lacked the free-play of the old booster - again it could be that the bracket was narrower than before. Everything worked, but seemed tighter - so I applied some good lubricant to the moving parts - pivot point and push-rod link mostly.

I installed the booster and hooked up the brake pedal -everything seems to work and function well with no hang-ups or issues - works very smoothly.

Here is a shot of it installed in my car:



A shot of Dave's car
with the 9" booster
installed

- Allan

Mounting the Master Cylinder

Push Rod Adjustment

We'd be remiss if we didn't mention that you may need to adjust your booster pushrod, specifically, the one on the front of the booster, like this one:

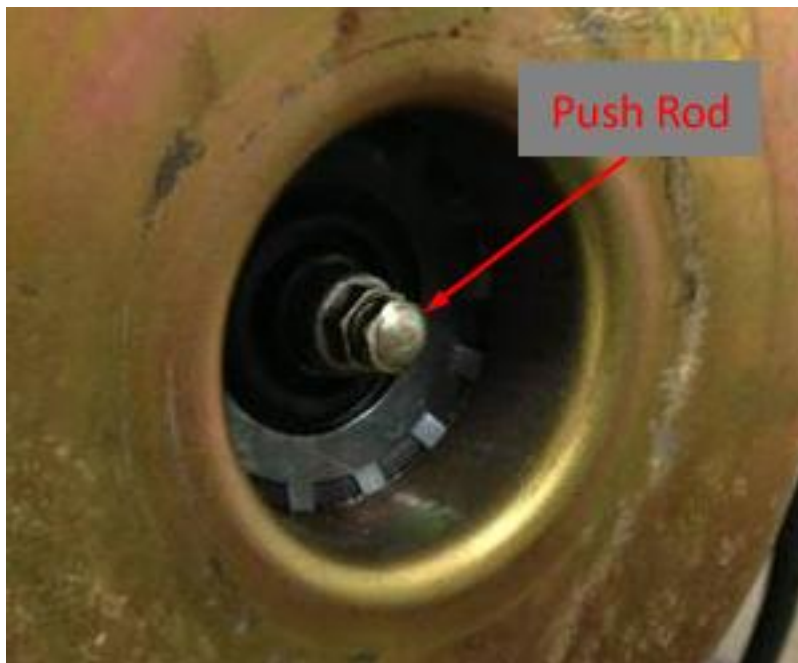

By placing a straightedge across the hole, I measured the gap to my pushrod as 1/8th inch. I don't know if that's optimal, or even correct, but it seems to work for me. Proper adjustment of the pushrod is critical – make it too long and the pushrod will apply pressure to the Master Cylinder even when you're not using the brakes – called "pre-load". This might A) make your brake drag, and B) cause your brakes to eventually lock up. A pre-load condition doesn't allow the Master Cylinder piston to fully return after each application of the brakes. As a cumulative effect, this excess pressure will slowly build and eventually it can lock up the brakes entirely. If your push rod is too short, you will need to push the brake pedal further to fully actuate the brakes and the pedal will be overall less responsive / soft.

I wasn't able to find the specs for say a 78 Corvette, but since the Corvette is the original application for the master cylinder used here and the Corvette also uses a very similar vacuum booster, if you can find the Corvette push rod specs, its probably what you need here too.

It's relatively easy to tell if the rod is too long. Its not easy to push that Master Cylinder piston by hand, so if you're trying to mount the Master Cylinder to the booster and it seems like it just doesn't want to mount flush and or it seems like something "springy" is preventing you from getting the Master Cylinder all the way onto the two booster studs, the booster pushrod might be too long. This is a good reason to mount the master cylinder onto the two booster studs and then push it all the way on by hand, rather than sticking it on half way and then using the nuts on both studs to push it the rest of the way.

Are there tools to measure and adjust the push rod?

Yes - CPP (Classic Performance Products) makes one:

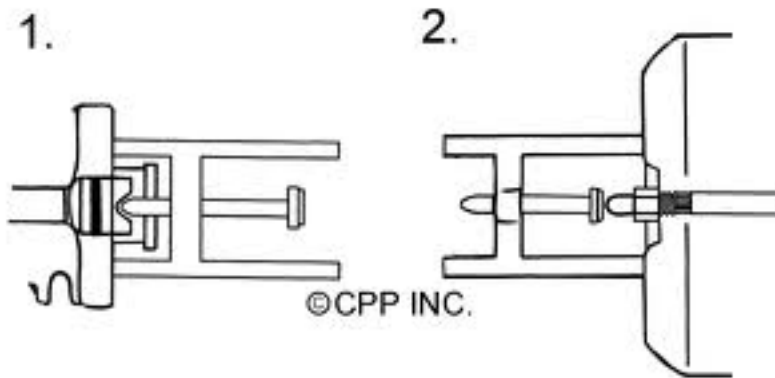

Calculating the adjustment isn't that difficult though and I've seen plenty of homemade adjustment tools that worked just fine. I've also done some visual tests as well - for example, pop the cap off of the Master cylinder and then very slowly push the brake pedal - be careful here, you don't want fluid going all over - but this does give you some idea of how much play you have in the brake pedal before you start pushing fluid - a little crude perhaps, but gives you a rough idea. I also push the brake with my hand - your leg is too strong and not nearly as precise - you want to "feel" the play in the pedal. For example, for me, there is a slight movement before the pedal moves the linkage, so obviously I have some slop in the pedal to rear push rod connection. Then, I can feel the pedal engage the booster, but not the master cylinder and within a few millimeters of movement, I can feel the master cylinder piston resist against my hand. With the cap off, I can also see when things start moving. That last gap in resistance, between the "feel" of the booster engagement and then within a few millimeters, the greater resistance of the master cylinder, tells me my adjustment is probably ok. If the booster was always resisting the master cylinder due to an overly long pushrod, I'd expect to feel the harder resistance immediately, rather than as a noticeable transition.

I started by calculating what I thought was the right adjustment, then verifying my "pedal play" with the process above. I'm no expert in booster pushrod adjustment, so this is just some detail on how I did it, but use your best judgment, or better yet, make a measuring tool.

Proportioning Valve

I did some prep work on the master cylinder, proportioning valve and brake switch connections. This sort of thing can eat up time quickly and I want most of my time spent on the mechanical swap rather than trying to find brake fittings - besides, I'd like some confidence going in that I've a reasonable chance of getting the lines back together!

The proportioning valve from the kit I have is a very common prop valve used on GM applications - I have the exact same one on my 57 Chevy and never knew it - I got that one from a junk yard years ago. I see this style of valve on a lot of modified "hotrods" with a disc / drum combo. It sells for around \$60 on Amazon. Picture:

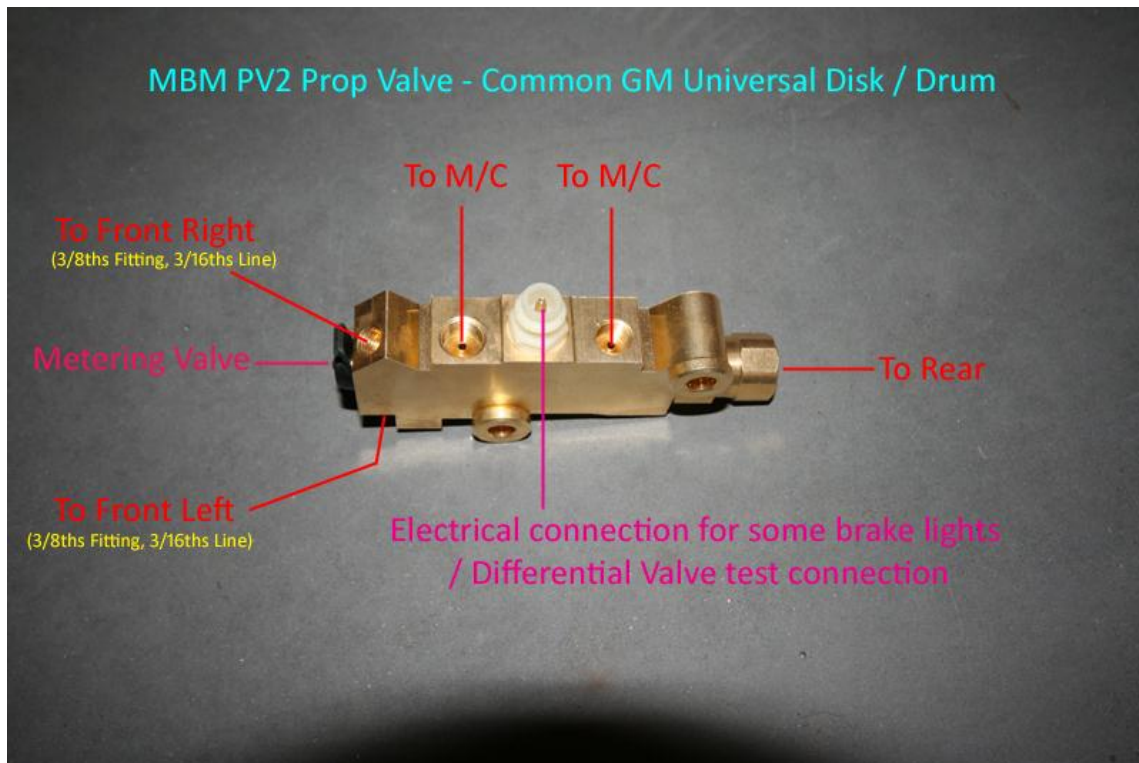

Now, there are many methods to hook up the stock brake light switch (including not using the stock brake light switch at all), I'm presenting two here - I can't say which is better, but here's what you'll need if you want to try it my way: (see next page)

1 - A 3/8ths thread-size union. This happens to be a compression union but you won't need the end nuts or the compression parts - just the threaded rod. Note that this union does have ends that *should* mate well with the double flare fittings, but you really shouldn't use compression fittings in general - I'm only using it for its threaded rod, not for the compression function.

2 - A 3/16ths line tee. You CANNOT use just any tee of the right size, you need the double-flare mating surface inside so that your lines will get tight and not leak.

3 - a 9/16th threaded fitting that reduces down to a 3/16ths line. May be called 9/16ths - 3/8ths.

4 - The brake light switch. This new one came with my kit, but I don't see why you couldn't use the old one.



Assembly Option 1

This is option 1 - it preserves the two front ports for the calipers and keeps the switch wires out of the way. Potential downsides include interference from the booster given how far back it goes before you can hook up the rear line. It doesn't do much for a tidy line set up either.

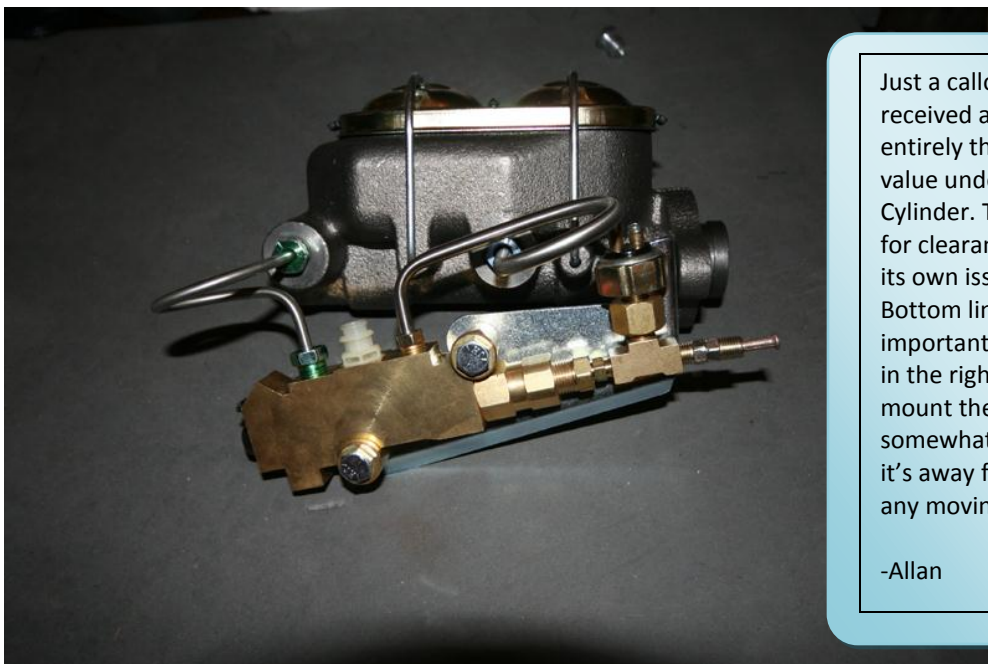
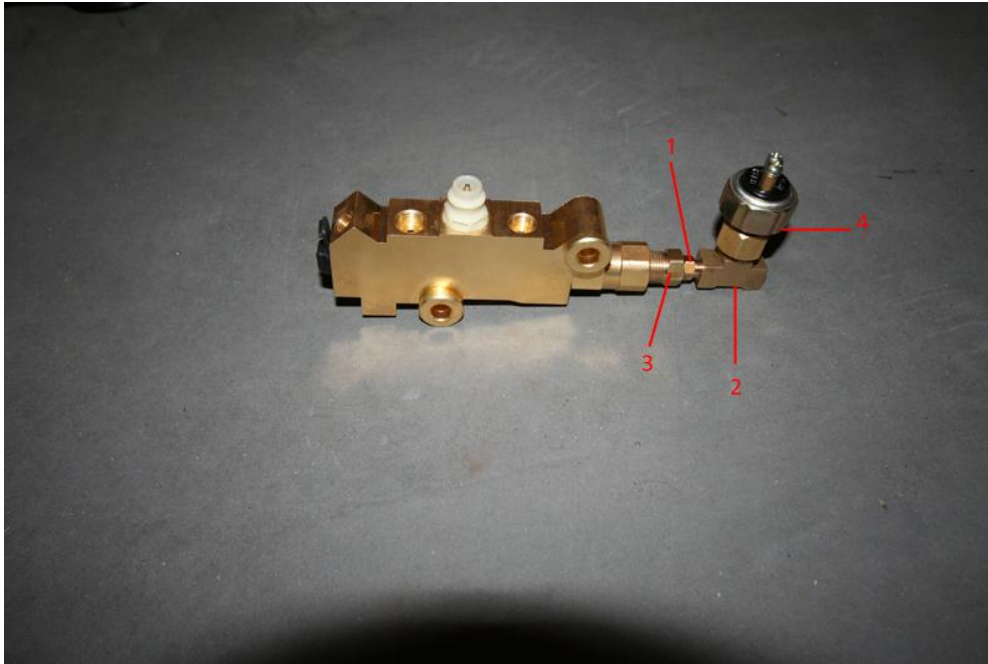

Just a callout here - Dave received a different bracket entirely that mounted the Prop-value under the Master Cylinder. This is likely beneficial for clearance purposes, but has its own issues for line routing. Bottom line is that it's important to get the right lines in the right holes, how you mount the thing though is somewhat irrelevant, provided it's away from heat and clear of any moving parts.

-Allan

Assembly Option 2

This option will make for nicer line routing and give extra space at the back for running the rear line, BUT it uses one of the front ports for the switch and relies on the lower port to tee-off for the calipers. Option 1 is the most common configuration for the front and rear lines, but I looked at the manufactures website and a PDF of the Prop valve - They say its an acceptable alternative to tee-off the lower line to the calipers. My gut tells me I want the calipers to have an independent line out of the prop valve, but looking at it - there's only one 3/16th line feeding the calipers from the M/C anyway and it doesn't seem to matter if its splits internal or external to the prop valve.

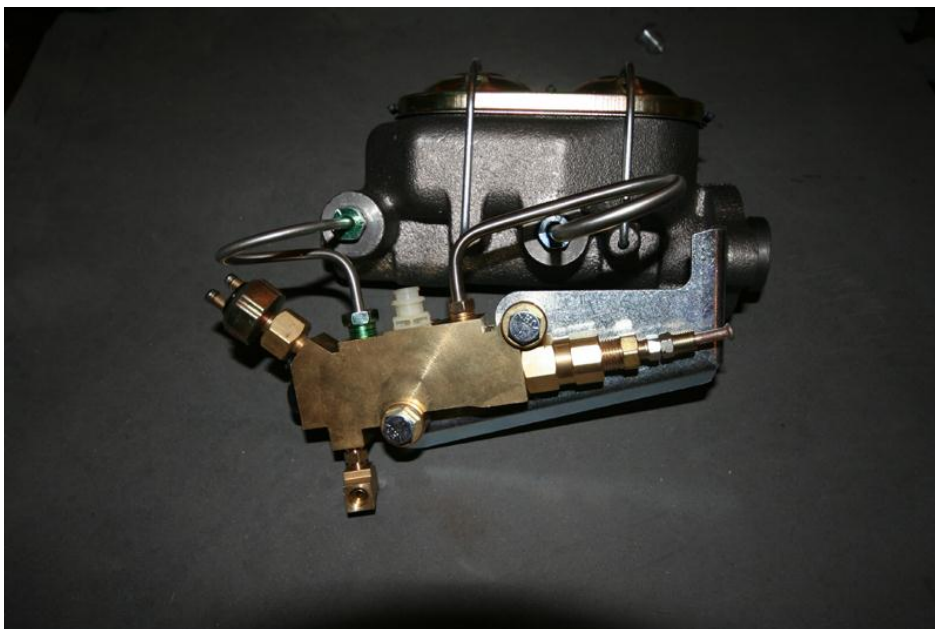
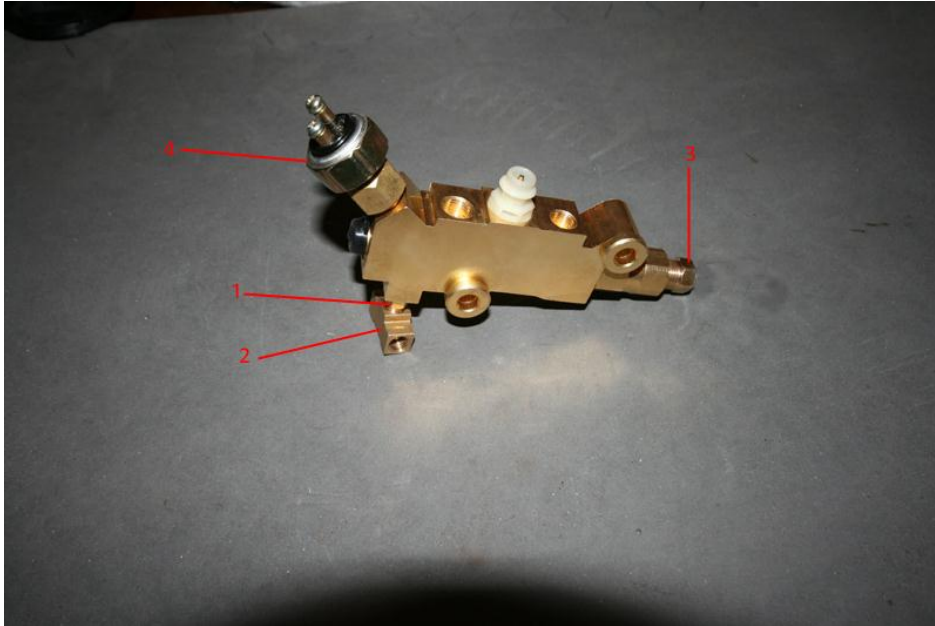

So there it is - a couple of options for the brake switch and the connections I'm using to hook everything together to the prop valve. It took quite a while in the parts store to come up with the right bits and pieces - you might find a better selection and be able to make substitutes or better choices.

With this squared away, and assuming it all works under pressure (it should) I ought to be able to get the lines connected and bled with a minimum of fuss. The potential weak point is the compression union, but in that event I'd just make up a short piece of 3/16 line with the right fittings on each end.

NOTE-- Just to add to the confusion about the Auto City Classic disc brake kit: I (Dave - bigbrownpilot) got an entirely different proportioning valve bracket than the type in the box-o-parts sent to Allan (Treozen). This one was designed to attach to the RH stud on the booster and mount backwards- rear port in front. It places the proportioning valve under the master cylinder, and the steel lines then crisscrossed to the respective ports. I thought that was a stupid way to mount it, so I modified it to allow me to mount the bracket off the LH booster stud with the rear brake inlet facing aft as God intended. I was able to bend the lines and get it all connected. Of course, there is little room between the rear brake line fitting and the booster to add brass couplings and adapters, so I used the 9/16" x 18 fitting in the kit and a 3/8" fitting to make a 6" long 90-degree brake line. I was able to bend all the existing lines enough to re-use them, so the factory front brake lines go to the two front ports on the PV. I took the rear line and moved it to the far LH side of the firewall and bent it so it is horizontal behind the hood hinge, and attached the rear brake residual pressure valve. That left me with about a 2" gap between my new 90-degree line from the aft port of the PV to the residual valve. I was able to find a towed trailer brake tee with one 3/16" male inverted flare fitting and two 3/16" female IF fittings at NAPA to hook it all together with the brake pressure switch and adapter in one of the female ports and the 3/16" fitting from the new 90 I made in the other.



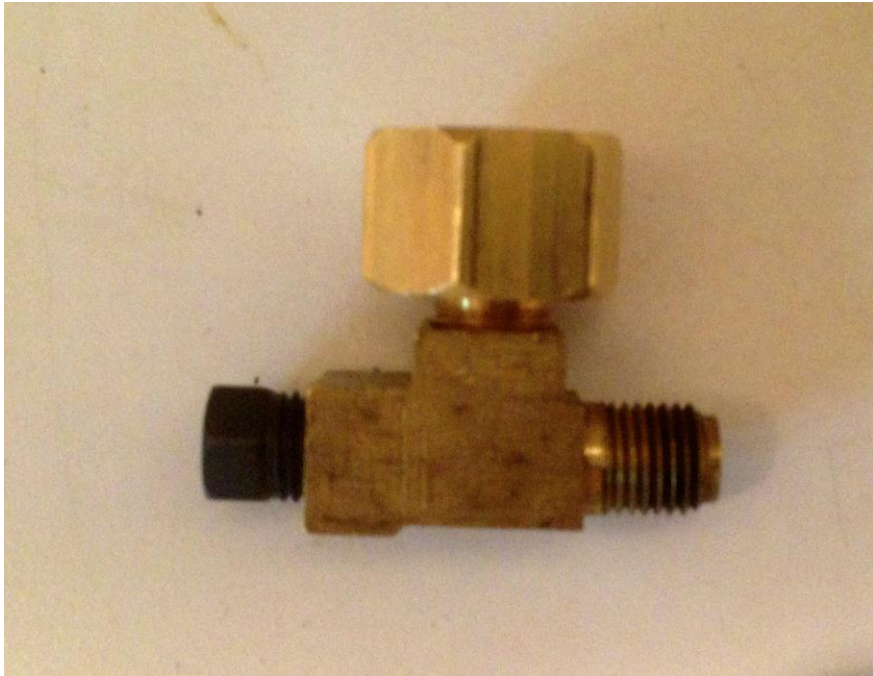
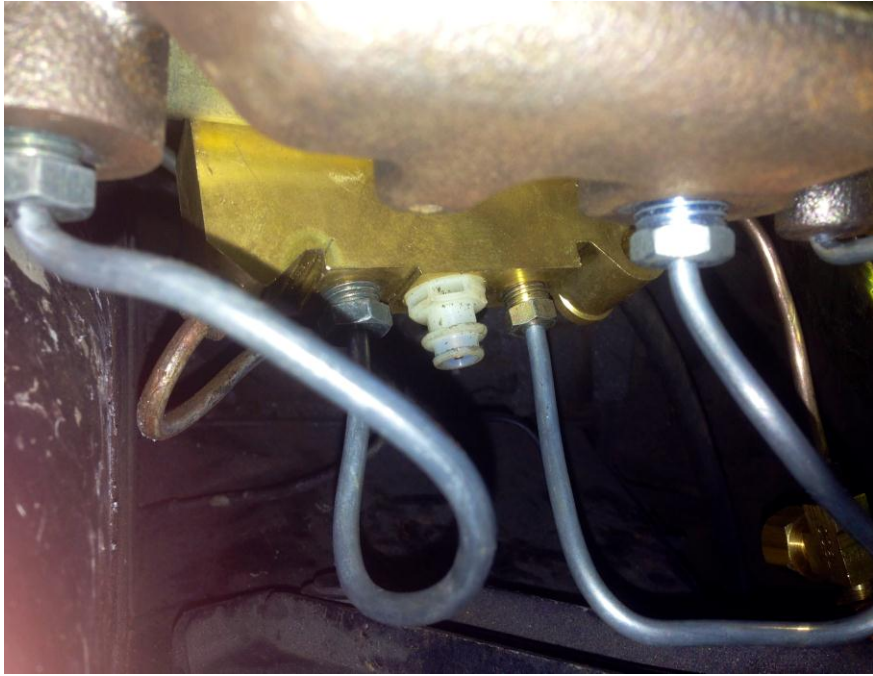

Brake Lines and Flares

I don't have a lot to say about this really, it's all pretty standard, but I did want to do a few things. I got to thinking that perhaps not everyone knows how to make a double flare for a brake line, and since it critical, I figured I'd give you a quick *"this is how I do it"* tutorial - but I'm sure, as with most things, there's more than one right way...

First thing you'll need is few specialty tools, but they are available at most auto shops, Harbor Freight, pretty much any tool supplier.



What we have here is a standard (and inexpensive \$30 or less) flaring kit. Make sure you get one that will flare the size of line you are working with - for example, not all of them will do 3/16ths, which is what the '63 Thunderbird (and I assume most cars of the era) run.

You will need enough brake line fittings—3/16 line diameter, 3/8 x 24 thread, and 3/8 hex.

You'll need something to cut the line - these rotary style cutters are cheap (\$10 give or take) and they work well if used correctly. NOTE: Rotary cutters are not specifically recommended if you're working with stainless. A rasp or file is also a good idea.

Step 1: cut the line



The trick to using these rotary cutters correctly is to BE PATIENT. Yes, you can tighten down the wheel and get that line to cut faster, but all you'll do is squish the line some and make it hard to get the flare tool to work. Here is how I do it:

1. Snug-up the cutting wheel to the line, you want it to be a little hard to spin the cutting tool on the line.
2. Spin the cutting tool on the line (flip it over and over) It might be a bit tough for the first spin, but after that it goes pretty easy.
3. When the cutting tool can flip back and forth by itself (so still clamped to the line, but no longer tight) snug the cutting wheel again by giving the handle on the cutting tool a slight turn - and I do mean slight... what works for me is to turn the black handle to the next "notch" - so maybe you're turning it 1/4 inch at most. Then repeat step 2. Keep doing this until the line cuts all the way though.



Note the “notches” in the tool handle. Only turn to the next notch when tightening the blade during cutting, it’s all you should need.

-Allan

You'll end up with this:





Next, use the reamer (the triangle thing on the cutting tool, see above) to even out and smooth the edges of the hole - ultimately you're making the interior diameter of the line close to what it should be and correcting for any "squish" caused by the cutting wheel. You'll get this:



If you have rough edges or some loose metal strands, you can use the rasp to lightly clean up the surface - make sure the end stays flat.

Next - clamp the line into the proper sized hole in the flaring tool and use the flare-adapter to measure how much line you need to leave sticking out - see below. Make sure to use the adapter size that matches your line size - in this case, 3/16ths.

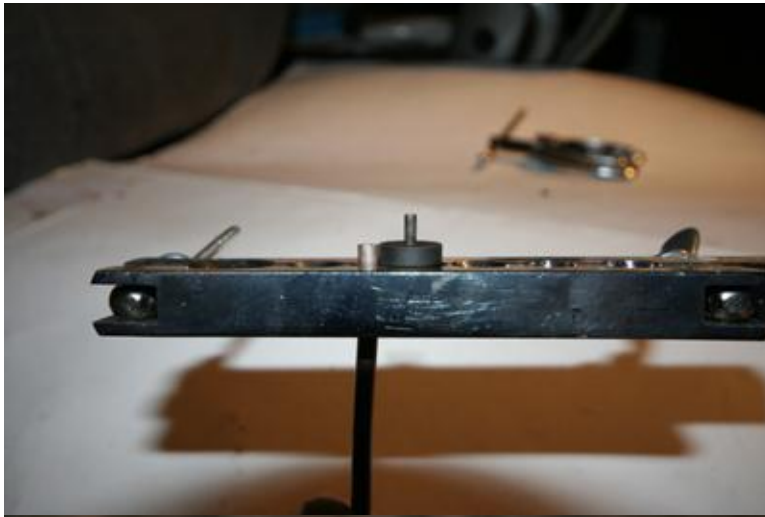

When you have that measured, tighten up the clamp (nice and tight, but you shouldn't need tools) and stick the pin-side of the flare adapter in the the line:

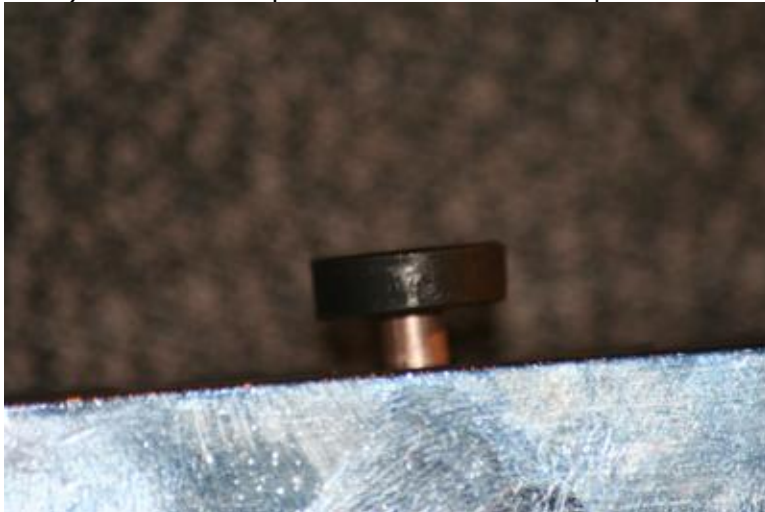

Next, attach the yoke (the pointy thing with the threads 🤖) to the clamp, line it up over the adapter and line, and begin to tighten. NOTE: you should not need a tool to do this - it does get hard at the end, but depending on the size of line, this really doesn't require extra leverage or anything.



You want to tighten it so that the adapter ends up sitting flush with the clamp:





Next, back out the yoke and remove the adapter - sometimes it gets a bit stuck and you need to break it loose with some pliers, but usually its free.

At this point, you'll have something that looks like this in the clamp:

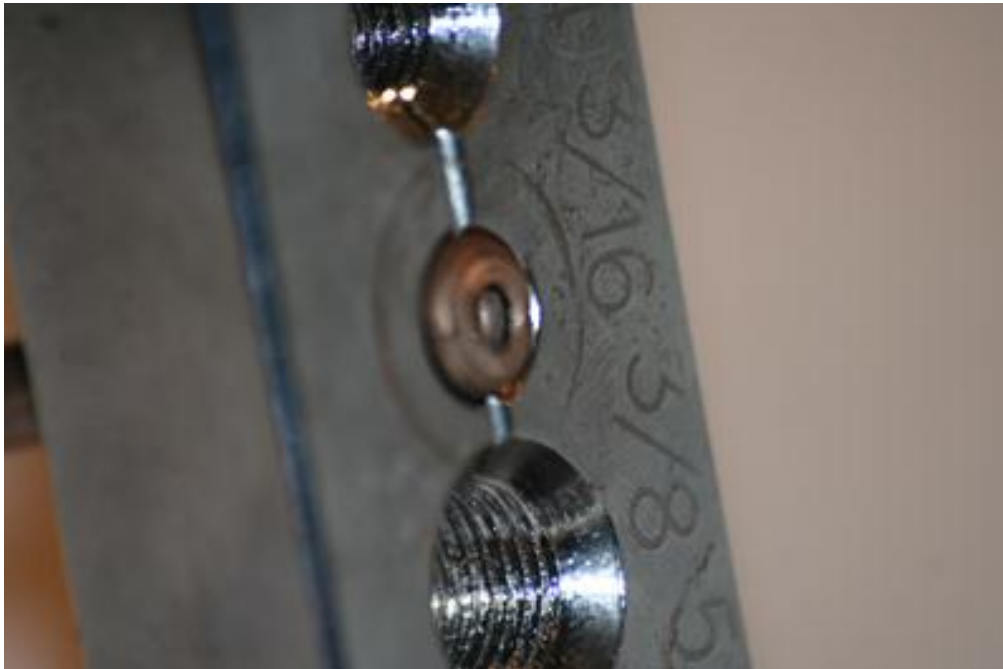

Next step is to repeat the process with the yoke, only this time; no adapter. This can be a bit harder, but again, you shouldn't need tools - just some grunt.



Finally, remove the yoke and loosen the clamp. Remove the line and slip on BOTH of the threaded fittings you want to use. I recommended adding both because it's so easy to forget, and you won't get the 2nd one on it you flare the other end first - (Been there, done that sooooo many times).



And there it is - double flare. I used this process for all my connections - zero leaks

Here are some shots of the front driver's side line:





The line I used is a copper-nickel alloy and I cannot recommend it enough. It meets SAE specifications, wont rust and bends easily - in fact, I installed the passenger-side line, making the bends BY HAND, to stock locations, as I went - try that with regular steel. Yes it is a little more expensive - It cost me \$32 for a 25ft roll - same size and length of roll in plain steel is only \$16 - so twice the price...but TRUST me... I've never had brake lines be such a joy to build - no kinks and bend something wrong? No biggie, it bends back. It holds it shape very well too. I got mine from Amazon, search "SUR&R Auto Parts (SRRBREZ100)" 25ft was enough to do both front sides, the lines from the master to prop valve and replace both rear lines from the flex hose to the wheels. I was also able to use my new (but incorrect for '63) rear flex hose since I was bending new lines.

A Word About Residual Pressure Valves

Assuming you use the kit that comes with the master cylinder and prop valve, its recommended that you install a 10lb residual pressure valve between the prop valve rear outlet and the line going to the rear wheels. If you don't, you may not get a firm pedal. If you bought the "basic kit" that doesn't come with master cylinder or prop valve, then you have more options - 1) use a master cylinder with the residual valve built in to it (several options) or 2) Use an adjustable prop valve with a residual valve built in. In any case, the residual valve is not expensive in installs easily. There are two common types of residual valve, the 10lb (usually red in color) and the 2lb (usually blue in color). You want the 10lb for this application. Essentially, the residual pressure valve holds some pressure in the rear line, just enough to counter some of the return pressure provided by the rear drum springs. This enables the rear drum brakes to apply quicker and reduce the volume of fluid required to push the brake shoe out to contact the brake drum. This also helps balance the brakes some front to rear (particularly when using a non-adjustable proportioning valve) and typically gives a higher, firmer pedal. The 2lb valve is typically used in applications where the master cylinder is below the level of the front calipers, but that doesn't apply to the 61-63 thunderbird.

There are multiple brands available and Amazon, Summit or Jegs are excellent sources. I used Willwood Part number 260-3279 (\$20 from Summit). The 3/16ths brake line fittings fit into the 1/8" NPT Female inlet and outlets - be sure to connect the residual pressure valve so that the valve is flowing in the correct direction, one end is the inlet (Master Cylinder side) the other is the outlet (towards the rear brakes). It's also recommended that you install the residual valve as close to the Master Cylinder as possible.

Residual pressure valves also have a reputation for leaking. Use your best judgment here, but I ended up using some Oatey thread sealer rated to 3000/10000 PSI (gas/liquid) bought from lowes.

DISC BRAKES FRONT AND DRUMS REAR WITH MASTER ON FIREWALL

- disc/drum, firewall



A disc/drum combination valve (PV2) is the easiest way to properly balance your braking system. The combination valve is two valves in one. It provides metering to the front which prevents nose dive and proportioning to the rear which prevents rear wheel lock up. We also recommend the addition of a 10 lb residual valve (RPV10) to the rear drum brakes.

Example installation instructions (not the Willwood valve I used, but similar)

Installation Instructions for 631030 & 631031 2 lb. & 10 lb. Residual Pressure Valves

SPECIFICATIONS

- Brake Line Pressure Retained (psi): 2 psi (blue) & 10 psi (red)
- Residual Valve Finish: Blue & Red anodized Fitting Attachment 1
- Fitting Attachment 1: 1/8" NPT Female threads
- Fitting Attachment 2: 1/2"-20 Female threads

1. Remove the black inverted flare nut from the valve.
2. Slide the nut over any standard 3/16" O.D. brake line and flare end of brake line using a flare tool such as JEGS #555-80087.
3. Install flare nut with brake line into valve. Check for leaks before operating vehicle.

Typical 10lb Residual Valve:

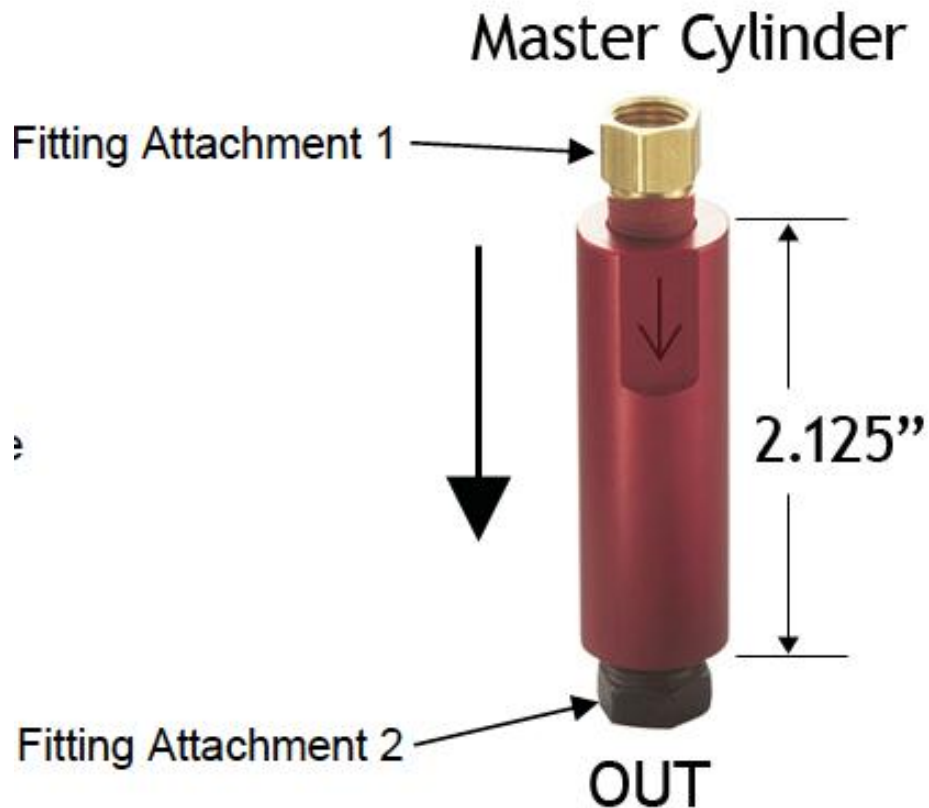

WARNING Proper operation of your brakes is essential for your safety and the safety of others. Any brake service should be performed ONLY by persons experienced in the installation and proper operation of brake systems. It is the responsibility of the person installing any brake component or kit to determine the suitability of the component or kit for the particular application. DO NOT DRIVE WITH UNTESTED BRAKES!

Bleeding Brakes

I won't go too far into this because it's a topic all of its own, but suffice to say, you'll need to bleed your entire system. There are several methods; I tried pressure bleeding with a pressure bleed kit (worked ok) and a one-man pedal-pump bleed (worked OK). I think the best method is still the old fashioned two-man bleed where one of you pumps the pedal and the other bleeds, is the best and most reliable IMHO. I also hear mixed reviews of the vacuum bleeders, so that's another option. For cars of this era, remember to start with the rear wheel cylinder furthest from the Master Cylinder (usually rear passenger) then move to rear driver, front passenger and finally front driver. If using anything other than a pressure bleed system, it's also a good idea to top off your master cylinder after every few pumps (pedal or vacuum).

Note: Don't forget to bench-bleed the new Master Cylinder – its pretty easy, and CRITICAL. Also take your time; it can take a while to get all the air out.

Additional Topics

Did I consider using pre-bent line kits or stainless lines?

Yes, but discounted for a few reasons:

- 1) Most critically, nothing pre-bent would have fitted up to the proportioning valve. Assuming the lines were long enough, I'd have needed to cut, re-bend and flare the proportioning valve end. If the lines were too short, I would have needed to use a union, and that's just another place for fluid to leak. Same issue on the rear end – Pre-bent lines would have assumed use of the stock and correct 1963 rear flex hose. The hose I bought from a T-Bird parts supplier was supposed to be for a '63, but the junction on the end was quite different. I believe the correct hose is available on eBay, but I'd already bought the other one. Bottom line though is that by using my own lines, I was able to bend them as needed.
- 2) Most, if not all, of the benefits of stainless are replicated by the copper-nickel alloy, with none of the downsides. Stainless is harder to bend, harder to flare and harder to seat - not impossible of course, but harder. So for me, unless I really needed chrome-looking brake lines, there wasn't much point in going with stainless. Copper-Nickel doesn't corrode, meets all DOT and SAE standards and if you really wanted, I'm sure could be polished up
- 3) Performance - the copper-Nickel alloy meets all the same standards as stainless. Stainless does out perform in the higher ranges - for example, stainless steel line has a 6000 PSI +/- burst rating...which is great...but the braking system in our cars is very likely only putting out 1500 -2000 PSI Max, and most specs seem to suggest pressure at the front calipers is more like 1,200 – and rear drums would be less. So unless your "Arnold Swartz-a-hulk" and have a right thigh the size of a redwood tree, you won't be close to needing that 6000 PSI burst rating anyway. The Copper Nickel alloy is 3000 PSI - so about 1000 PSI margin.

4) Most pre-bent kits seem to come in 6 pieces. I'm not sure what they are, but 6 pieces suggest at least one piece is split and joined with a union. By making my own lines, I can run lines without any unions and eliminate another potential leak source.

5) Cost – a pre-bent stainless kit will run between \$150 and \$190 based on a few suppliers I checked with - That versus \$32 for the coil of Copper-Nickel. In comparison, pre-bent stainless is very costly, is actually disadvantageous versus copper-nickel and would still require some bending and flaring anyway. Additionally, since I'm not working with a rolling chassis but a completely built car, pre-bent lines may have been harder to install given the pre-bent angles and bends I'd have to negotiate during the process. Even just a coil of stainless is \$55 – and that's only 20 feet.

Can you use the stock 14" wheels with this kit?

Standard 14inch wheels will not fit with this kit, and there are very few kits (if any) where a standard 14inch wheel will fit. There are 14 inch wheels from other vehicles out there designed to fit with disc brakes, but you won't be able to run the stock '61-'63 wheels. I believe you can use later T-Bird parts for a disc swap and run a stock 14-inch wheel – but don't quote me on that. For this kit though, you need either a 14" wheel designed for discs or a larger wheel, your stock stuff will not fit.

What's this I hear about low drag calipers?

Sometime in the late 70's – I want to say '78, give or take, GM introduced the concept of the Low Drag caliper. The idea was that a change in the piston seal design would cause the piston to retract further away from the disc, thus, low drag and presumably, better mileage and lower rate of pad replacement (or some other corporate spin). This also necessitated a step-bore master cylinder (also called "Quick Take-up") – essentially a two-step process where when activated, the master cylinder first delivered a high volume of fluid at low pressure move the caliper piston out, THEN delivered a lower volume of fluid but at a higher pressure to actually clamp the disc. This all happened seamlessly, and seemingly, it worked. The problem with the low drag caliper in non-stock applications however, is that it's a rare case where you can use a step-bore master cylinder. Most all conversions I see use a standard master cylinder and while I believe I found a few step-bores that might work, it would be trial and error because the master cylinder bore is different and most (perhaps all) step bore master cylinders won't fit on a standard vacuum booster.

So, how does this impact this kit?

Well..... you may, or may not, have an issue with the low drag caliper. Best bet here is to install, bleed and find out. Using the pad spacers will help. If you do find the low drag caliper is causing a low pedal or inability to lock the front wheels / lack of braking power, there are several good options for replacement aftermarket calipers. This is one of these "phantom" issues where, while its real, it doesn't seem to impact everyone - could be a personal "feel" thing or due to the fact that not all the metric calipers are low drag, but it's very difficult to tell which and the low drag and non-low drag calipers all got mixed together in the re-manufacturing process (or so I'm told). The bottom line is that many people never notice the difference, so this is one of those things I wouldn't worry about until you need to, and you'll only need to worry if you can't get a decent pedal feel / brake performance. The good news is that the aftermarket calipers, while more expensive, will eliminate the problem and you can even upgrade to a bigger bore caliper, which is generally a good thing.

Brake Hose/Banjo Bolt leaks:

Leaks at the banjo-bolt end of the front brake hoses are common. There should have been copper seal washers provided, two each per banjo bolt. The copper washers have a flat side and a rounded side; the flat side goes towards the hose. Don't reuse old washers!

Copper takes a set and time, tighten, let sit for 15-30 minutes, retighten. Copper will conform to the surface irregularity. Repeat until leak stops. Thirty-five ft./lbs. I think, is the torque setting. Another quick check is to make sure you have the correct side of the fitting facing the caliper. In the pic you can see the brass on one side is milled flat all the way to the hose. That's the side that mates up to the caliper.

- Dave

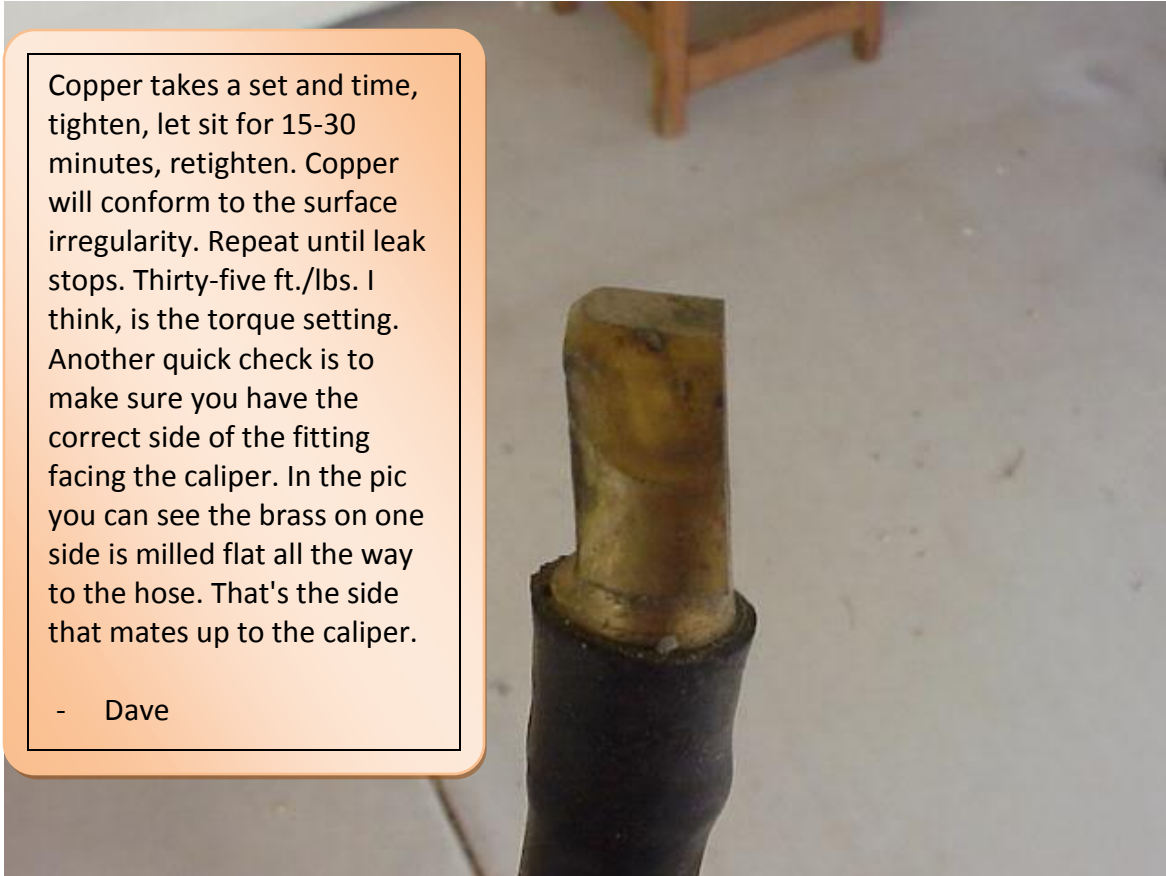

Booster Fitment & Master Cylinder Clearance

Unless you mount the booster a bit lower, the shock tower mount (for the cross brace between the cowl and shock tower) may overlap the master cylinder cover to the point where you can't get the cover off without damaging it. Another related problem was that I couldn't use the Motive Products plate to pressure-bleed the brakes until I modified the mounting pad. I did some major surgery to the mount-- yes, I will still be able to use the stock cross brace, but there is a lot less meat around the first hole. I had to cut the mounting pad as shown in the picture below, and then I also had to take some of the edge of the actual brace off to get the front bail onto my master cylinder. Then I had enough clearance for the front bail until I tried to mount the cross brace. I used the cutting wheel on the Dremel and chamfered the edges to get enough clearance to mount the cross brace member. Obviously, there are other ways to avoid this-- mount the master cylinder a tad lower when modifying the bracket, use a different MC, etc. Allan didn't have this issue, and was able to remove the cover from his Master Cylinder and use a pressure bleed plate without making any modifications to the cross-brace mount (see 2nd picture), so it may depend somewhat on the master cylinder you get – but something to be aware of."



Picture 2 – Allan's Install



Is this a bolt on kit? What about the sellers that describe this and similar kits as "a couple hours of garage work with no special tools or torches required"?

Don't believe a word of it. I don't mean to intimidate you or anything but I've never met a "bolt on kit" that was a bolt on. This kit took me three days to install and several weeks to fine-tune thereafter, and I've done this before. In principle it's easy, but in practice there's a lot more to it. They also don't tell you about what's missing - for example, not all complete kits are 100% complete - proportioning valves are often left out and in most cases you'll need to run new brake lines. Even if you get lucky and can bend your existing lines around, you'll still need to make some for the proportioning valve to master cylinder - that requires a tubing flare tool at minimum - its not expensive or hard to do, but its a tool you probably don't have unless you have done brake lines or fuel lines before - so I'd call that a special tool. In my view, what they mean by "a couple hours of garage work" is that you can bolt their stuff on in that time - but that absolutely does not mean you are rolling out of the garage after a single afternoon.

Nothing you need to do is that hard or something first-timer couldn't handle, but unless you get real lucky, it won't be a simple bolt-on job and roll out in a few hours. Prepare for a longer than expected build time and try have a clear schedule so that you can commit to several hours of work - My kids tend to limit the number of hours I can hide out in the garage, but its often a blessing in disguise - keeps me from getting too frustrated or tired, which leads to mistakes and re-work.

Final Thoughts

Allan:

On the assumption I recommend the kit at all, my advice is to buy the basic kit. Most likely you're going to want to change out the 7" booster for a 9" booster anyway, an adjustable proportioning valve is generally worthwhile (versus the static one provided in the complete kit) and the master cylinder can be sourced locally (and probably available over the counter immediately) from about any parts store. The "complete" kit isn't really a kit at all given the general poor fit, and so you're not really losing anything – in fact you'll save \$\$ and get an overall better system.

SO, would I recommend the basic kit? Depends....I firmly believe no kit is truly "bolt on" and at \$650 +/- for even the complete kit, there's some room for forgiveness in terms of how well the kit goes together. My recommendation on this kit would also depend a lot on to whom I was recommending it – do you have some experience with this sort of thing? Yes? – Then sure, go for it, just know that you're really buying the spindle adaptor and bracket and that some mods are necessary. If you're new to this though? – Perhaps not. I've tried to give a pretty detailed walk through here, but it can't replace experience. Auto City Classic also has horrible customer service - they didn't even respond to my email or call, and I was even nice and professional on both occasions – So just know that it's a bit iffy if they'll be available to help if you get stuck, and even if they were, its clear as day that they have no idea what a 61-63 Thunderbird needs (I mean, lets be honest, it appears they don't even know what their own caliper brackets need....casting bumps on calipers anyone?). All in all, this kit will get you disc brakes and the eventual system is comparable to that used on factory disc-equipped cars of similar weight and style, so while you wont be "track ready" you will have improved your braking system significantly over stock.

Dave:

If I had it to do over again, I would only buy the basic kit with the new caliper brackets, calipers, rotors, and hoses. Even then, I might be tempted to buy everything "a la carte" and get the correct calipers so I didn't have to cut the bump off. I would definitely go with the SSBC 9" booster kit and associated adapters for the front and rear threaded rods, also use the stock bracket assembly with enlarging the lower holes to get it to fit the SSBC booster, get a master cylinder that doesn't interfere with the cross brace and shock tower mount, and choose my own proportioning valve, mounting bracket, and lines from Speedway Motors. Also, it is easy enough to make lines using Allan's recommendation. I chose to make maximum use of my existing lines, but flared and bent my own line to connect the rear of the proportioning valve to a tee for the brake pressure switch and the rear brake residual pressure valve.

Appendix

Vacuum Booster / Brake Pedal Assembly Diagram

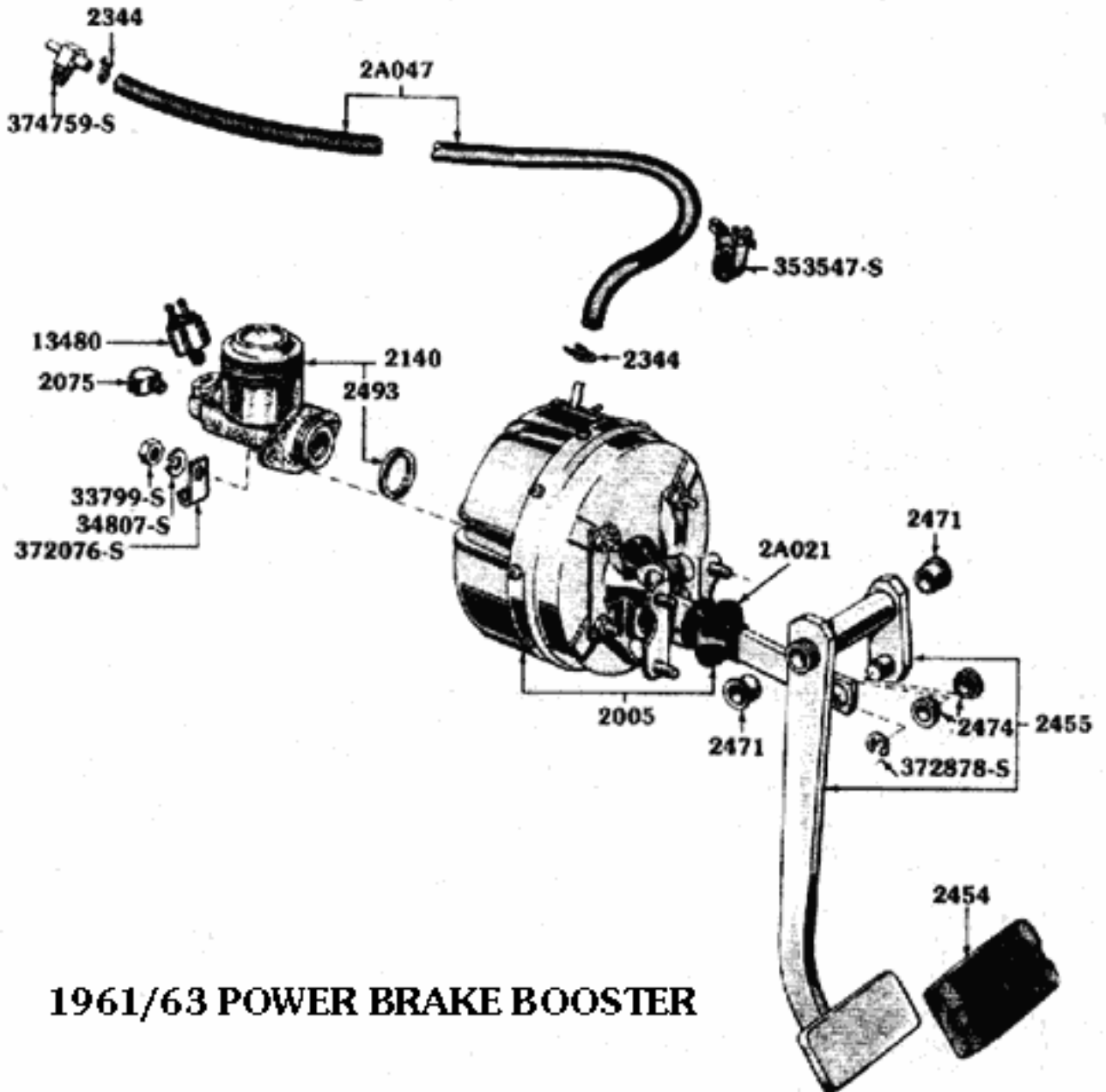

Vacuum Booster – Exploded View Diagram

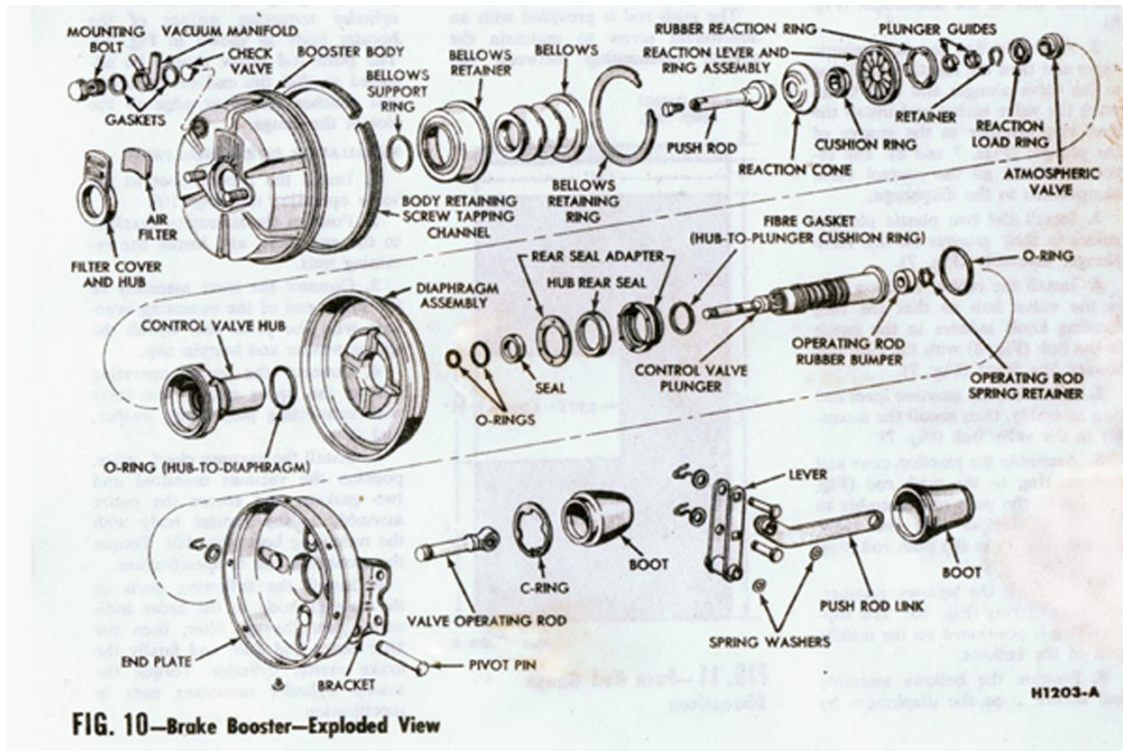

Rear pushrod linkage - close-up

